

# Palsonic

# DVD PLAYER

DVD / SVCD / MP3 / VCD / CD / CD-R & CD-RW PLAYER WITH KARAOKE

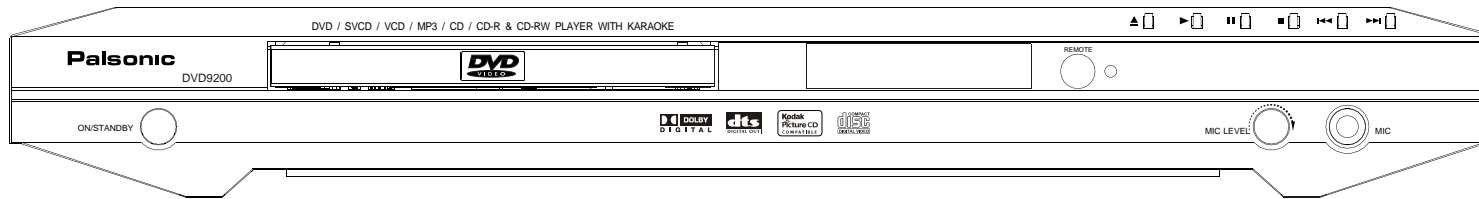

## Operating Manual DVD 9200



Super VCD



Before attempting to connect, operate or adjust this product, please read these instructions completely and keep this manual for future reference.

Getting started

Basic operation

PBC functions & MP3/JPEG operations

Playback mode

Karaoke operation

Digest & program

Initial settings

Troubleshooting

Terms

# Getting started

## Dear customers:

May we take this opportunity to thank you for purchasing this DVD player. We strongly recommend that you carefully study the operating instructions before operating the unit.

Manufactured under license from Dolby Laboratories. "Dolby" and the double-D symbol are trademarks of Dolby Laboratories. Confidential Unpublished Works. © 1992-1997 Dolby Laboratories, Inc. All rights reserved.

"DTS" and "DTS Digital Out" are trademarks of Digital Theater Systems, Inc.

This product incorporates copyright protection technology that is protected by method claims of certain U.S. patents and other intellectual Property rights owned by Macrovision corporation and other rights owners. Use of this copyright protection technology must be authorised by Macrovision, and is intended for home and other limited viewing uses. Only unless authorised by Macrovision Reverse engineering or disassembly is prohibited.

## Main Features

- Fully compatible with DVD, SVCD, CVD, MP3, DVCD, VCD1.0/1.1/2.0, CD-DA, CD-R, CD-RW, KODAK PICTURE CD and CD-I DISC.
- DTS-compatible digital audio output.
- Compatible with full DVD playback functions: multi-angle, multi-language, multi-story, parental control, etc.
- Advanced 10-bit/27MHz video D/A converter with over 500 lines of horizontal resolution.
- Video output: Normal video output, S-video output.
- Audio output: Dolby Digital 5.1ch output, Dolby Digital 2ch mixed stereo output, MPEG-II Audio output, optical and coaxial digital output, Linear PCM decoding output.
- 24-bit/96kHz audio D/A converter.
- 3-step zoom/smooth scan.
- NTSC/PAL TV system compatible.

## Features of playback specifications

- This product complies the MPEG II standardization law.
  - 720 X 480 @ 30Hz
  - 720 X 576 @ 25Hz
  - PAL and NTSC

## Features of audio specifications

- DTS (Digital Theater System) digital audio output.
- Dolby Digital 5.1ch decoding output.
- MPEG-II Audio output.
- Dolby Digital 2ch mixed-stereo decoding output.
- Linear PCM audio decoding output.
- MP3 audio decoding output.

## Karaoke features

- Digital multi-level key control.
- Mixed sound effect: single sound channel, stereo output.
- MIC inputs.

## Playback features

- Skipping ahead and skipping back.
- Multi-speed slow motion playback.
- 3-step zooming playback.
- 3-way repeat playback.
- Numeric selection.
- Programmable playback.
- Time search.



Before using the player, please ensure that the local AC voltage is suitable for this unit.

# Getting started

## Disc types

	Audio & Video	Disc size 12cm Single side, single layer/single side, double layer PAL and NTSC DVD disc Playback time 135min/240min max.
	Audio & Video	Disc size 12cm/8cm SVCD, CVD and VCD disc Playback time 74min/20min max
	Audio	Disc size 12cm/8cm CD disc Playback time 74min/20min max

## Disc maintenance

-Before playback, wipe the disc from the center hole toward the outer edge with a clean cloth.



Right



Wrong

-Never use benzine, thinner, cleaning fluid, static electricity prevention liquids or any other solvent.



Dirty disc may cause bad picture.

## Table of contents

<b>Getting Started</b>	P1-P6
<i>Features</i>	P1
<i>Disc types &amp; maintenance</i>	P2
<i>Safety precautions</i>	P3
<i>Accessories and remote control unit</i>	P4
<i>System connection</i>	P5
<i>Front panel</i>	P6
<b>Basic operation</b>	P7-P8
<i>Starting playback and function buttons</i>	P7
<i>Searching buttons and other buttons</i>	P8
<b>PBC &amp; Mp3 /JPEG functions</b>	P9
<b>Playback mode</b>	P11
<i>Karaoke operation</i>	P12
<i>Digest and program</i>	P13
<i>Initial settings</i>	P14
<i>Troubleshooting tips</i>	P17
<b>Definition of terms</b>	P18

Getting started

Basic operation

PBC functions & MP3/JPEG operations

Playback mode

Karaoke operation

Digest & program

Initial settings

Troubleshooting

Terms

# Getting started

## Safety precaution

WARNING



To avoid electrical shock, do not open the cabinet, refer servicing to qualified personnel only.

ATTENTION

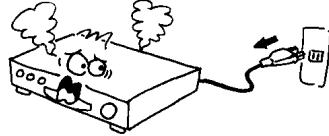

If smoke, an odour or noises are emitted from the unit, turn off the power and disconnect the AC power cord.

WARNING



Keep the unit away from flower vases, tubs, sinks, etc.. If liquids are spilled into the unit, serious damage could occur.

WARNING

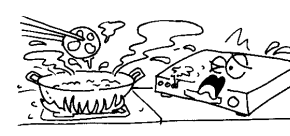

Do not expose this equipment to rain or moisture.

ATTENTION

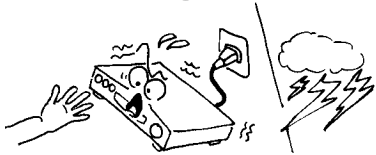

Touching the unit is dangerous, If thunder.

ATTENTION



When left unused for a long period of time, the unit should be unplugged from the household AC outlet.

WARNING



Do not block ventilation holes of the unit so that air can circulate freely.

ATTENTION



Be sure to turn the unit off and disconnect the AC power cord before cleaning the unit surface. If the surface is dirty, wipe clean with a cloth which has been dipped in a weak soap-and -water solution and wrung out thoroughly, and then wipe again with a dry cloth.

### Notes:

This unit is a class 1 laser product and uses a visible laser beam which could cause hazardous radiation exposure if directed. Be sure to operate it correctly as instructed.



The above items are true of not only this unit but also most of the household electronic products.

# Getting started

## Accessories

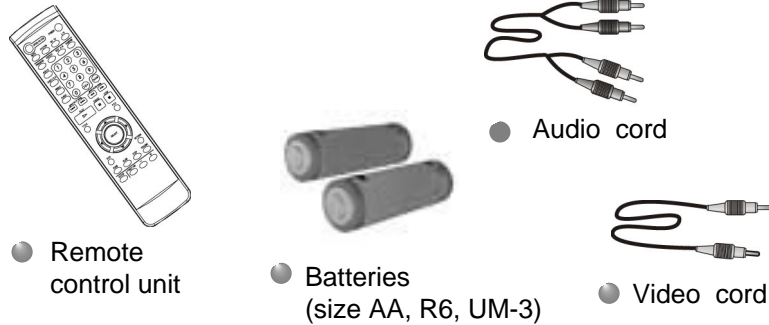

## Battery installation (remote control unit)

1. Remove the battery cover.
2. Insert two batteries (AA, R6, UM-3 type) making sure the polarity(+/-) matches the marks inside the unit.
3. Replace the cover.

- Do not attempt to recharge, short-circuit, disassemble, heat or throw the batteries into the fire.
- Do not mix old and new batteries.

## Remote control unit

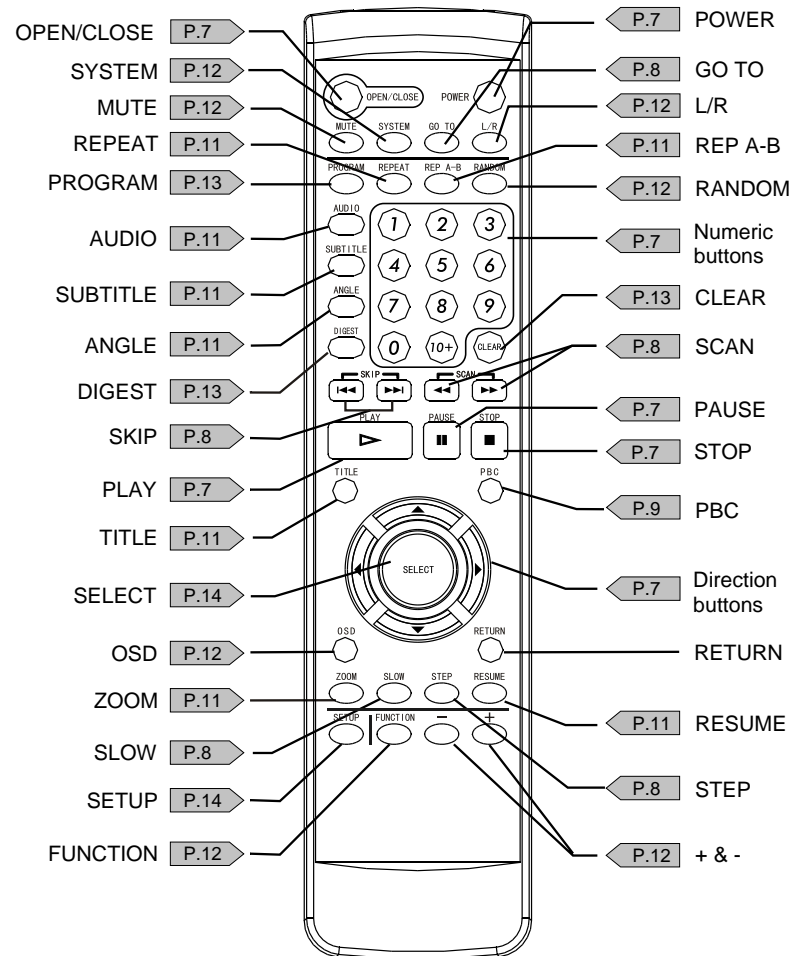

- Point remote control unit no more than 8m from the remote sensor and within about 60° of the front of the unit.

Weak batteries can leak and severely damage the remote control unit.

# Getting started

## System connection

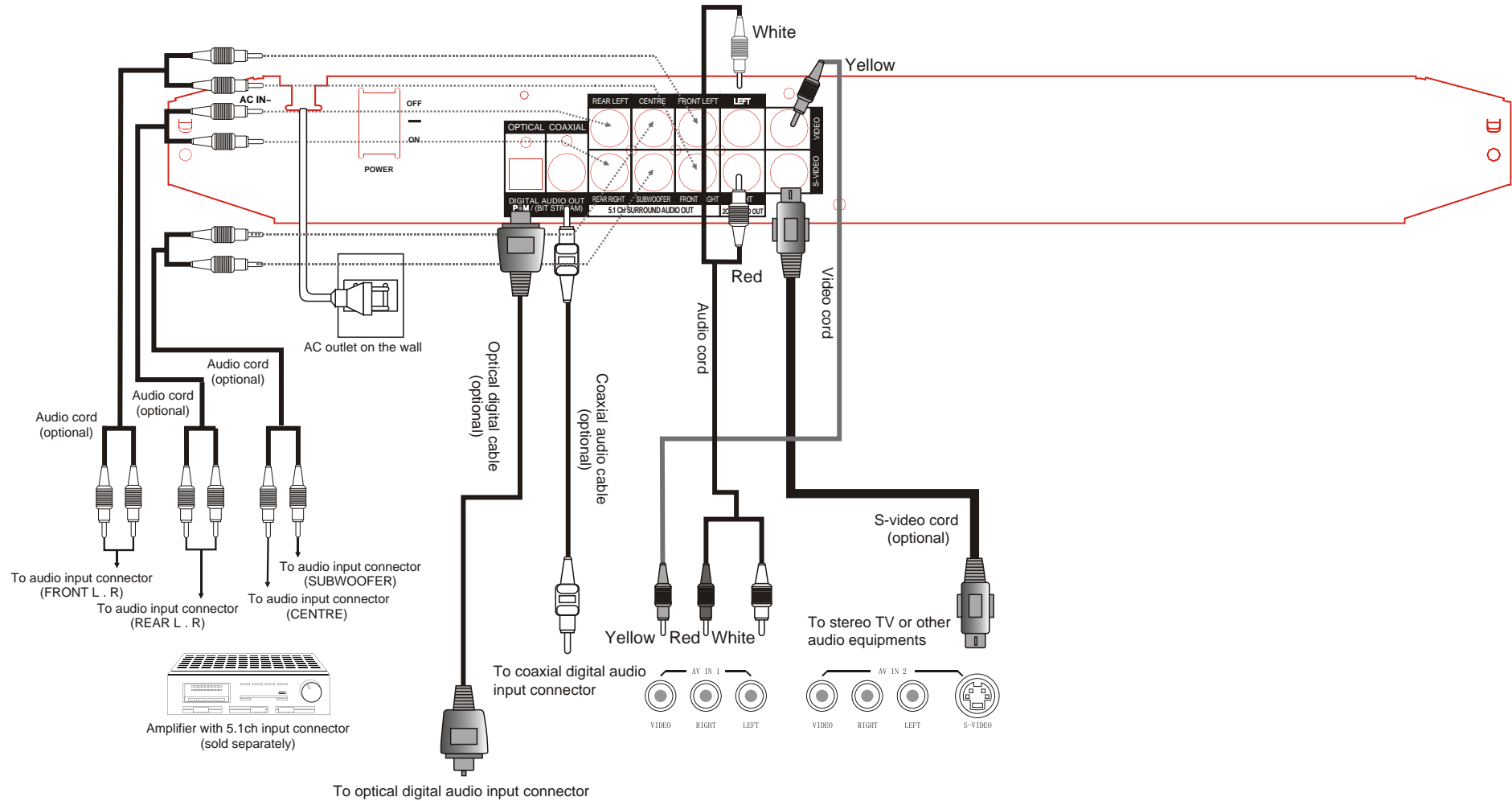

Turn off the power and keep AC cord pulled out from the outlet when connecting the system.

# Getting started

## Front panel

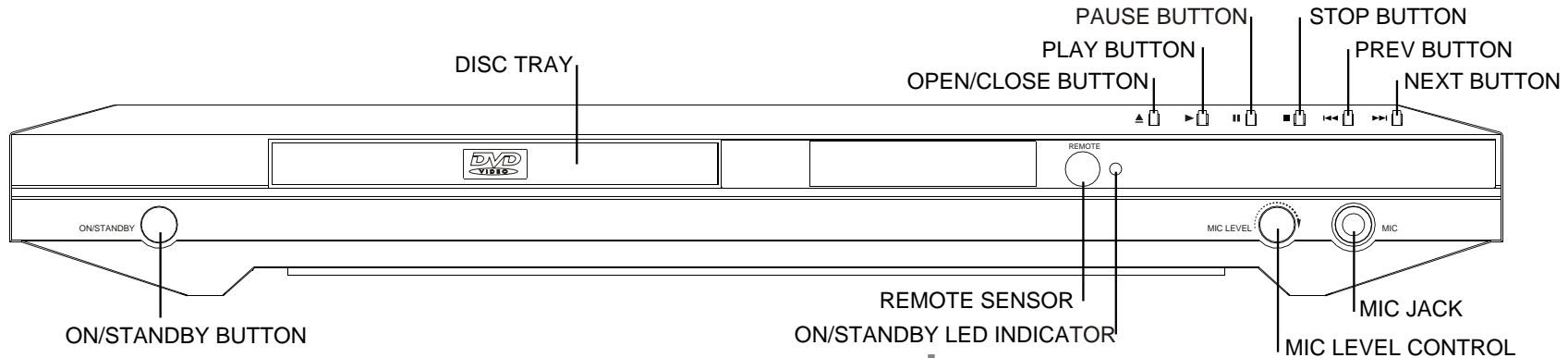

## Vacuum fluorescent Display

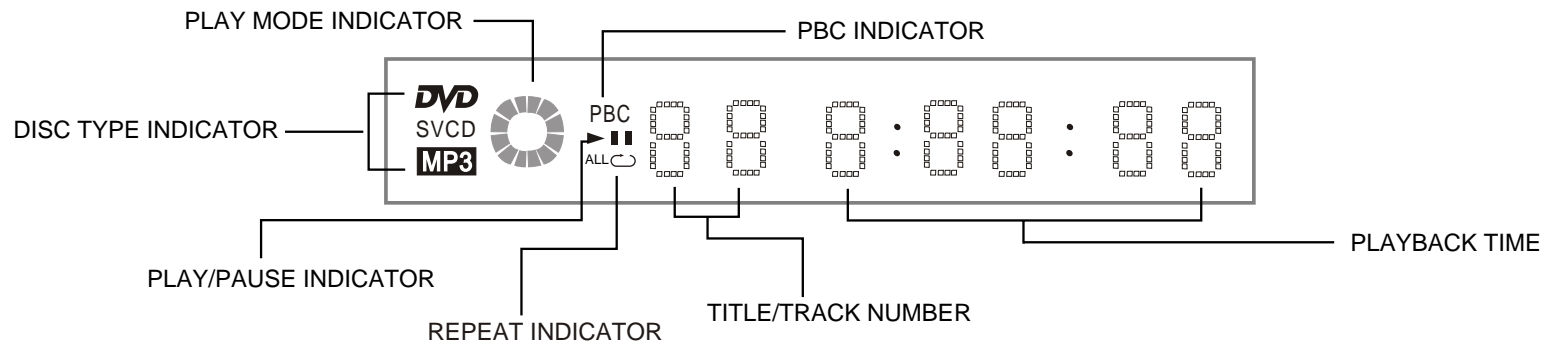

Most of the functions can be controlled by remote control unit.

# Basic operation

## Starting playback

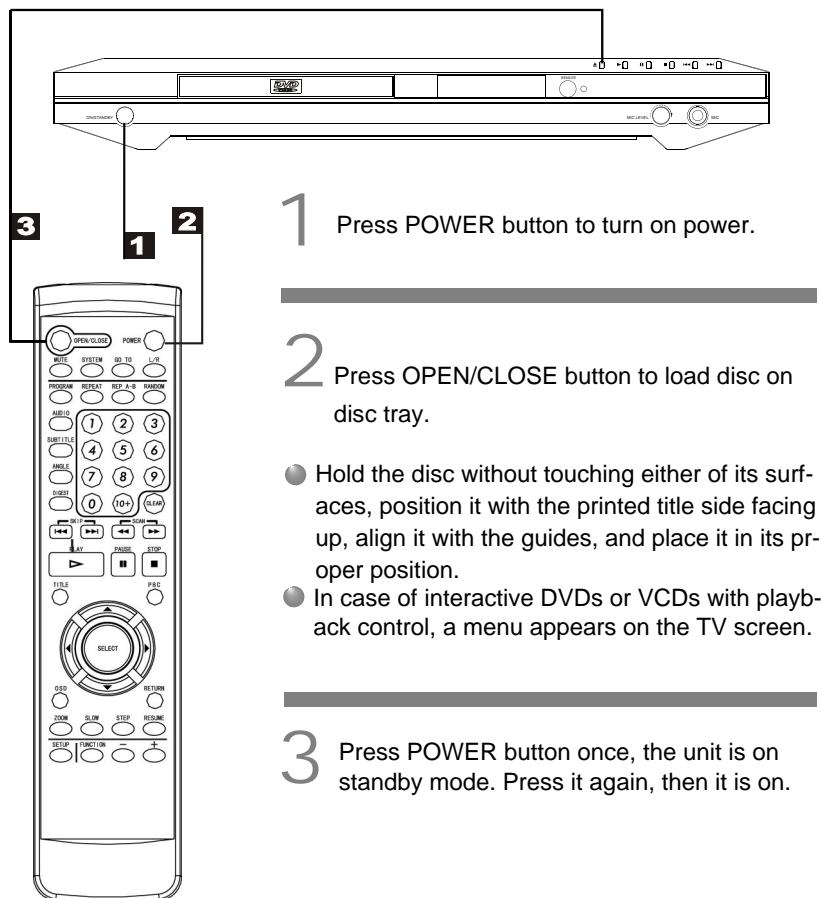

## Function buttons

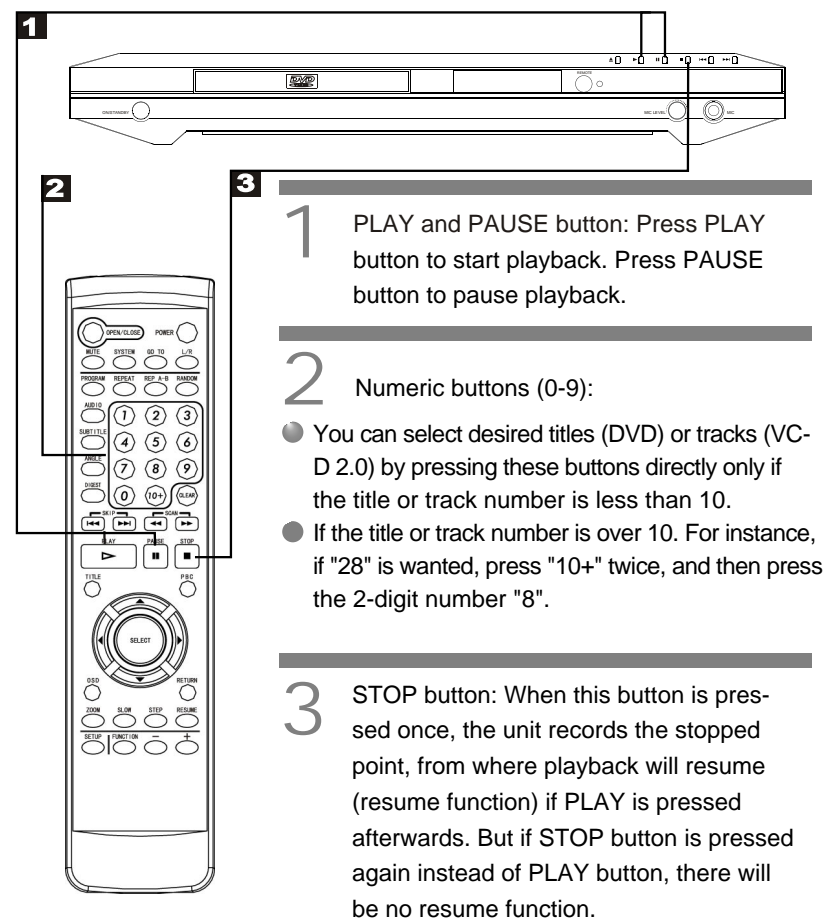

DVD discs possess super interactive function. Please normally use "◀▶" and "select" keys in operation of OSD menu.



# Basic operation

## Searching function buttons

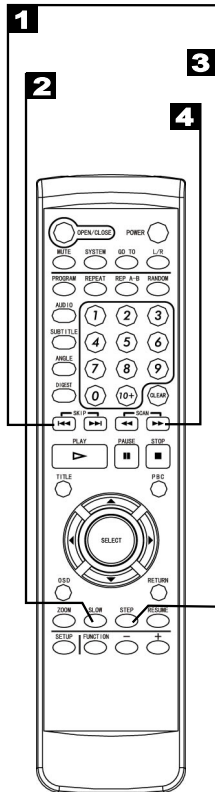
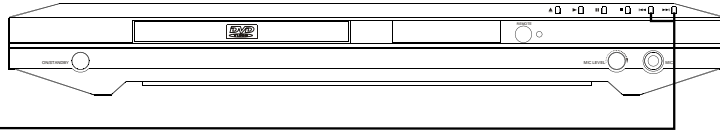

**1** SKIP button:  
Press these buttons to go to the previous/next chapter (DVD) or track (SVCD/VCD).

**2** SLOW button:  
Press this button to select slow-motion playback in forward and reverse direction at 1/2, 1/4, 1/8, 1/16 normal speed without sound (DVD). When play SVCD/VCD discs, press the button to select slow-motion playback in forward direction at 4-level speeds as 1/2, 1/4, 1/8, 1/16.

● Press PLAY button to return to normal playback.

**3** STEP button: You can enjoy picture frame by frame by pressing this button.

**4** SCAN button: These buttons allow skipping ahead/back at 4-level speeds .

● Press PLAY button to return to normal playback.

## Other buttons

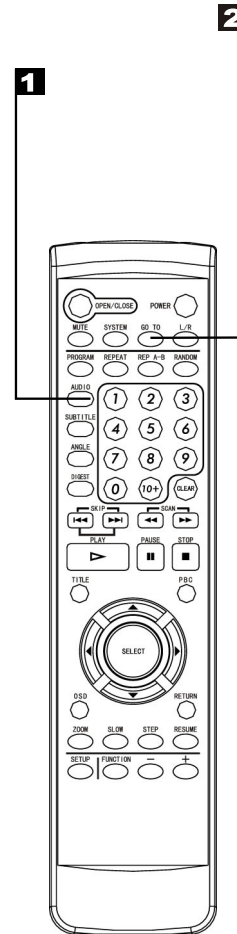

**1** Numeric buttons (0-9):  
These buttons can function with GO TO button or others (see page 7).

**2** GO TO button:  
Press this button to go to desired position. The player provides 3 search mode.

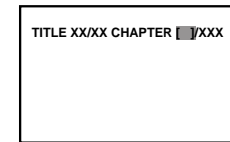

[DVD only]

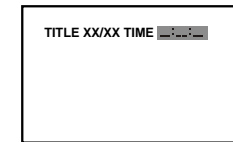

[DVD only]

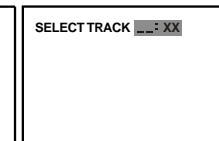
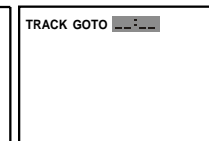
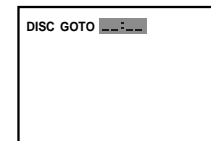

[CD/VCD/SVCD]

- When the above items are showed on TV screen, you can input numbers to locate desired sector, then press PLAY to commence play.
- The number you input is invalid if it is beyond the track's capacity.
- This function maybe can't work with some SVCD discs.



When "⊘" appears while a button is being operated, it means that the corresponding is prohibited by the player or disc.

# PBC functions & MP3 /JPEG operations

## PBC playback buttons

- When playing SVCD, VCD with PBC functions, you can enjoy simple interactive software on TV screen.
- When playback, there are such functions as track selection, stop, previous/next scene, fast forward/backward, return, play/pause and karaoke for you to select.
- PBC functions can be auto run after the disc is loaded and its logo appears on VFD.

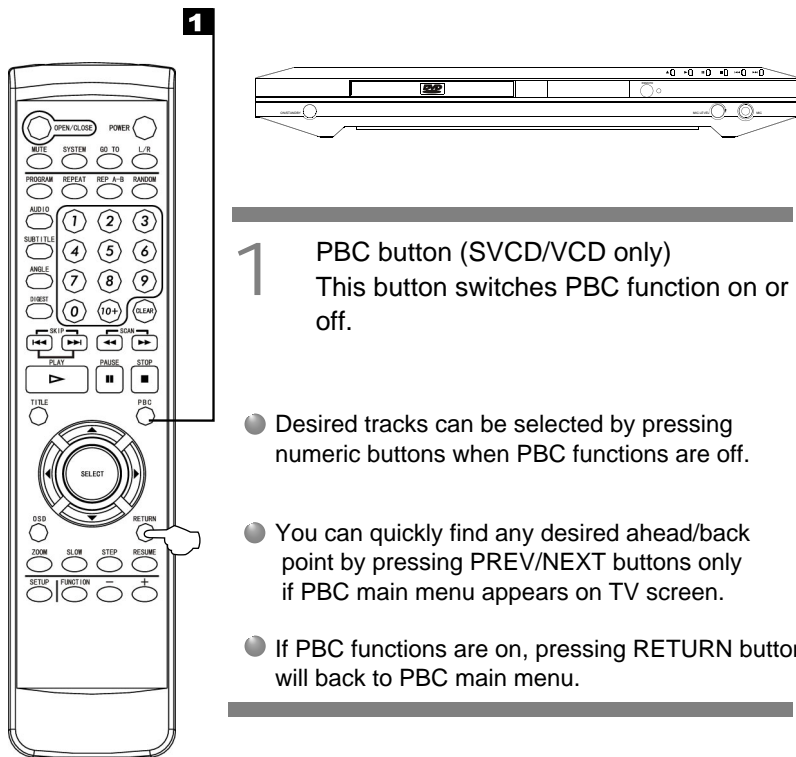

## MP3 operations

MP3 is a kind of audio compacted format adopted the third audio compacted layer mode in the international standard MPEG. Utilising MP3 format, the compress rate can reach 12 to 1 high. Therefore, only one MP3 compact disc can hold music over six hundred minutes or more than one hundred and fifty songs. Moreover, it's audio quality almost reaches the CD standard.

1 Press the OPEN/CLOSE button: Put in MP3 disc on label side, now system begins searching information on disc. Completing searching, the menu screen appears, now you can use "◀▶" and PLAY buttons to select song to play, or you can select desired song to play by pressing numeric buttons directly.

2 Prev & Next buttons: Their functions is to choose the previous or next song to be displayed.

3 Numeric buttons: Pressing number buttons on your remote controller, you can directly select the song which you want to enjoy to be played. For example, if you want to enjoy listing to the eighteenth song, please press "1" once , and then press "8".

4 STOP button: Press the button will stop playback .

 PBC functions allow you to select programs guided by simple interactive software.

# PBC functions & MP3 /JPEG operations

## JPEG operations

- Press OPEN/CLOSE:

Put KODAK JPEG disc properly, the system will search automatically. After searching, the direction arrows and PLAY button can be used to choose the option desired by the user. Also the numeric buttons can be used to select directly. Press NEXT/PREV/STOP buttons to control.

- Optional Play Modes:

- FOLDER - Play the catalogue.
- SINGLE - Play the selected song or JPEG picture once and stop.
- REP-ONE - Play the same song or JPEG picture over and over.
- FOLDER R - Repeat Play the catalogue.
- SHUFFLE - Randomly play each song or JPEG picture in the current directory.

- Sixteen slide show transition modes are provided, use "RESUME" button to select:

- mode 1: wipe top
- mode 2: wipe bottom
- mode 3: wipe left
- mode 4: wipe right
- mode 5: diagonal wipe left top
- mode 6: diagonal wipe right top
- mode 7: diagonal wipe left bottom
- mode 8: diagonal wipe right bottom
- mode 9: extend from centre h
- mode 10: extend from centre v

## JPEG operations

- mode 11: compress to centre h
- mode 12: compress to centre v
- mode 13: window h
- mode 14: window v
- mode 15: wipe from edge to centre
- mode 16: random
- mode 17: no

- Image transformation

There are four modes of transformation: "Invert", "Mirror", "Left" and "Right". The arrow keys are used to select.

- Up - Invert/Normal
- Down - Mirror/Normal
- Left - Turn left
- Right - Turn right

- Zoom

Press ZOOM button to enter ZOOM mode. Then press "FR and FF" button zoom in/out.

Note: during ZOOM function, slide show transition and image transformation are disabled.

- Stop

The "Stop" key is used to enable KODAK JPEG digest mode when in stop state. After it is enabled, up to 12 scaled down jpeg pictures will be displayed on the screen. The "Prev & Next" keys can be used to display the next/prev twelve pictures. By pressing a number key the corresponding picture will be enlarged to fill screen, and the digest mode will be cancelled.

# Playback mode

## Repeat playback mode buttons

The repeat functions that you can enjoy are dependent on the disc types played.

DVD: title repeat, chapter repeat and given portion repeat.

SVCD/VCD/CD: all tracks repeat, single track repeat and given portion.

REPEAT button: To press this button:

- You can repeatedly play a title (DVD) or all tracks (SVCD/VCD/CD) when "ALL" appears on VFD.
- You can repeatedly play a chapter (DVD) or a single Track (SVCD/VCD/CD) when "C" appears on VFD.
- You can cancel repeat functions when no "C" appears on VFD.
- When PBC is off, Repeat play can works with SVCD /VCD/CD.

REP A-B button:

- You can repeatedly play a given portion by operating as following:  
To press this button once to define the portion head  
To press this button again to define the portion toe.  
And then the portion will be played repeatedly.  
To press this button again to return to normal playback.

ZOOM button:

- Press this button during normal, zoom in or zoom out playback mode. This player can magnify a picture at 3 levels. Press this button to magnify picture and use direction buttons "◀▶" to select desired part of the zoomed picture.

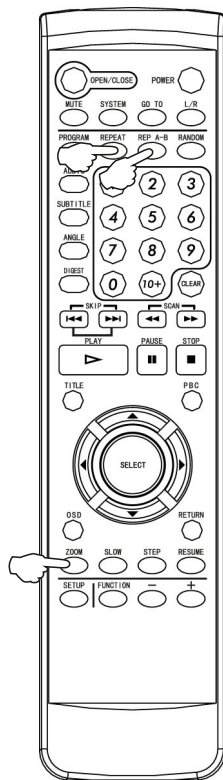

## Interactive function buttons

1 AUDIO button: To press this button, you can change the audio language from the one selected at the initial settings to a different language, if available.

2 SUBTITLE button: To press this button, you can change the subtitle language from the one selected at the initial settings to a different language, if available.

3 ANGLE button:  
Some DVDs may contain scenes which have been shot simultaneously from a number of different angles. For these discs, the same scene can be viewed from each of these different angles by using the ANGLE button.

4 RESUME button: When you press STOP button, the player can memorise the stopped point from which play will go on when you press RESUME button.

5 TITLE button:  
DVD disc:  
Press TITLE button, then the DVD menu or titles available on the disc will be displayed. Then you can use "◀▶" and SELECT button to select programs.

※ The buttons mentioned in 1-3 can work only when the disc played supports the corresponding functions.

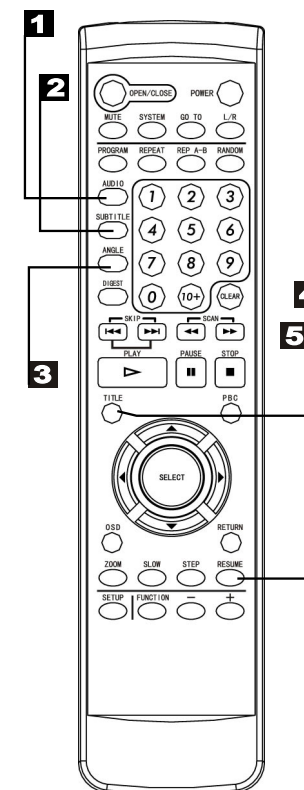

When this unit is not used, please turn off the power and leave no disc inside.

# Karaoke operation

## Karaoke function buttons

Before using karaoke, please turn on karaoke function in the setup menu.

**1** SYSTEM button:  
Press this button to select PAL, NTSC or MULTI.

**2** RANDOM button:  
Random mode allows you to play tracks randomly by pressing this button, pressing again will cancel random playback.

**3** FUNCTION button:  
Press to select volume, pitch. Then press "+" or "-" button for adjustment.

**4** MUTE button:  
Press this button to turn on/off the sound.

**5** L/R button:  
Press this button consecutively and the audio output will change as following:

→ MONO-LEFT → MONO-RIGHT → STEREO

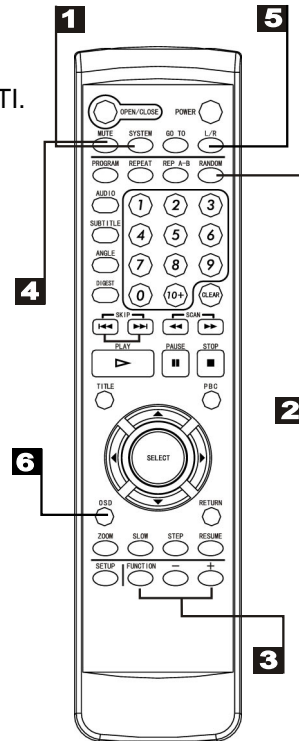

## Display and MIC echo adjustment

**6** OSD button:  
Press this button once to show main playback information on TV screen and press it again to show playback time. Press this button at the fifth time, and then the display will be cancelled.

- MIC volume adjustment  
You can adjust MIC volume by tuning MIC LEVEL knob on the front panel.

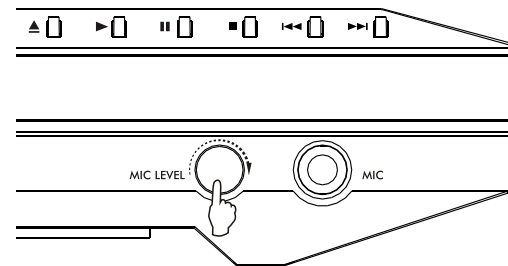

When playing karaoke, strong signal input will cause whistling. Please adjust MIC level knob while meeting with this case.

# Digest and program

## Digest function buttons

- DIGEST button:
- If playing DVD discs, press this button back to root menu screen
- If playing DVDs you can use the functions of DIGEST, PROGRAM and RANDOM.

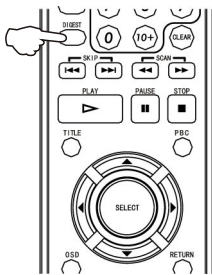

- 1 Press PROGRAM button. Then "PROGRAM" will appear on TV screen
- 2 Press the track number in the order you want.  
For example, if the track numbers you want to play are 1, 3 and 8, just input in the order of 1-3-8.
- 3 You can press CLEAR button to cancel and input again if you mis-input track numbers.
- 4 Now you can press "◀▶" and "SELECT" button to select "START" option and enjoy the desired tracks.

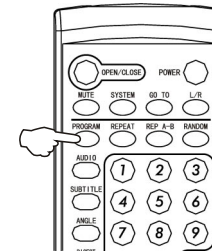

## Program functions

- When you want to play only partial tracks/chapters of a disc (DVDs) or to arrange the tracks/chapters playback order, you need program functions.  
Do as following:

# Initial settings

## Common procedures of initial settings

- Press SETUP button to get to the setup menu. Use direction buttons "◀▶" to select the preferred item and press **SELECT** button to confirm. After finishing settings, Press SETUP again to leave the setup menu main page to the TV display.

- Setup menu main page

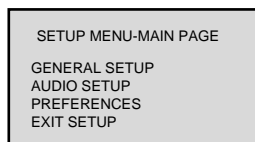

The following menu items can be changed:

**GENERAL SETUP:** selects the GENERAL PAGE menu.

**AUDIO SETUP:** selects the AUDIO SETUP PAGE menu.

**PREFERENCES:** selects the PREFERENCES PAGE menu.

**EXIT SETUP:** selects the item to leave the setup menu.

## General setup page

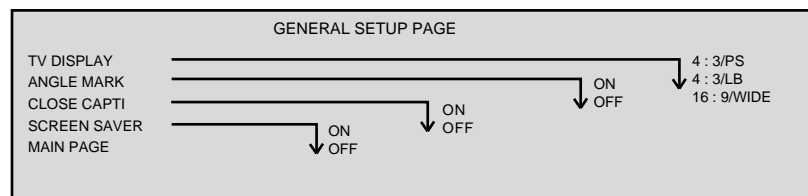

The following menu items can be changed:

**TV DISPLAY:** selects the aspect ratio of the playback picture.

4:3/NORMAL/PS: pan & scan display.

4:3/NORMAL/LB: letterbox display.

16:9/WIDE: widescreen display.

**ANGLE MARK:** viewing angles change option (if available). See changing the angles on page 11.

**CLOSE CAPTI:** Select caption ON or OFF.

**SCR SAVER:** this is to turn on/off screen saver.

**MAIN PAGE:** selects the menu setup MAIN PAGE.

## Audio setup page

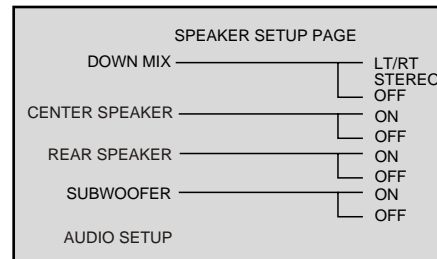
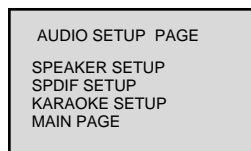

This page is for setup speaker output.

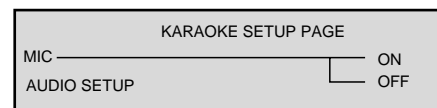
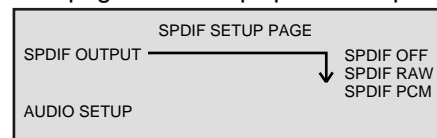

**DOWN MIX**

LT/RT: 2ch output, main channel with surround.

STEREO: 2ch output, main right channel with right surround; main left channel with left surround.

OFF: full 5.1ch output

**CENTER SPEAKER**  
ON/OFF: set centre speaker on/off.

**REAR SPEAKER**  
ON/OFF: set rear speaker on/off.

**SUBWOOFER**  
ON/OFF: set subwoofer speaker on/off.



Once the initial settings have been completed, the player can always be operated under the same conditions (especially with DVD discs). The settings will be retained in the memory even after turning the power off until the settings are changed.

# Initial settings

## Preferences setup page

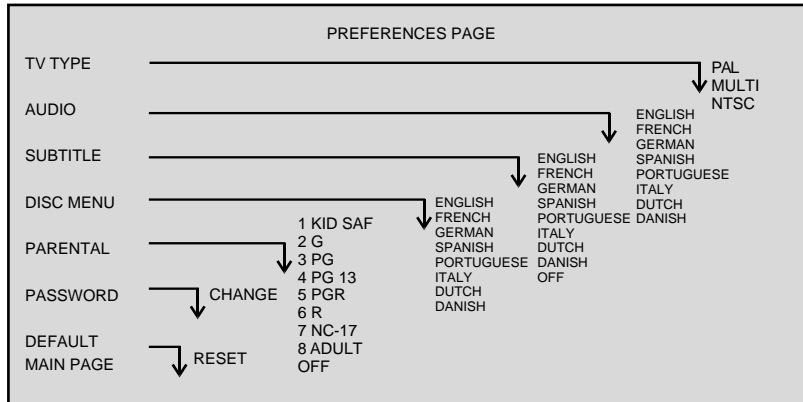

The following menu items can be changed:

**TV TYPE:** selects the type of television.

MULTI: automatic-self-selecting television sets.

NTSC

PAL

**AUDIO:** Selects a language for audio (if available).

**SUBTITLE:** Selects a language for subtitles (if available). no subtitles are display after selecting OFF.

**DISC MENU:** Selects a language for title menus or DVD menus (if available).

**PARENTAL [DVD only]:** This is to disable the playing of specified DVDs which are unsuitable for children. Some DVDs are encoded with specific rating level. If the rating level of the disc is higher than that preset in the setup operation, playback of the disc will be prohibited. After selecting one of the PARENTAL items the screen will change to the PASSWORD VERIFY page.

**PASSWORD [DVD only]:** Selects the menu setup PASSWORD CHANGE PAGE.

**DEFAULT:** Reset all settings according to factory default settings.

**MAIN PAGE:** Selects the menu setup MAIN PAGE.



Once the initial settings have been completed, the player can always be operated under the same conditions (especially with DVD discs). The settings will be retained in the memory even after turning the power off until the settings are changed.



# Initial settings and specifications

## Password verify page

PASSWORD VERIFY PAGE	
CURRENT PASSWORD	[ XXXX ]

**CURRENT PASSWORD:** Enter the current password. If the password is incorrect, the parental option will not be changed.

## Password change page

PASSWORD CHANGE PAGE	
OLD PASSWORD	[ XXXX ]
NEW PASSWORD	[ YYYY ]
CONFIRM PASSWORD	[ YYYY ]

**OLD PASSWORD:** Enter the OLD password. (Factory setting is 1369)

**NEW PASSWORD:** Enter the NEW password. Enter 4 digits from the remote control unit numeric buttons.

**CONFIRM PASSWORD:** Confirm the NEW password by entering it again. If the confirmation is incorrect, the Password Change Page will be displayed again.

## Electronical parameters

Item	Standard requirement	
Power source	AC 85-245V~, 50Hz/60Hz	
Power consumption	<35W	
Laser	Wave length: 655nm: Laser power: class 1	
Signal system	PAL/NTSC	
Digital audio output	Optical digital output: optical connector; Coaxial digital output: pin jack;	
Input	MIC	
	φ 6.3mm jack	
Output	S-video	Y output level: 1Vp-p(75Ω); C output level: 0.300Vp-p(75Ω)(PAL), 0.286Vp-p(75Ω) (NTSC); connector: S-terminal
	Video	Output level: 1 Vp-p(75Ω); connector: pin jack (1 systems)
	Audio	Output level: 2Vrm (1KHz, 0 dB); connector: pin jack. 5.1ch mixed output: 1 system (2 channels). 5.1ch discrete output: 1 system (5.1ch)
Audio characteristics	Frequency response	20Hz~20kHz
	S/N ratio	≥ 90dB
	Dynamic range	≥ 80dB(1kHz)
	Total harmonic distortion	≤ -65dB(1kHz)

## Other specifications

Accessories	Handset x 1, Video cord x 1 Battery x 2 (AA, R6, UM-3 type), Audio cord x 1
Dimensions	430 (W) X 255 (D) X 55 (H) mm
Carton size	480 (W) X 335 (D) X 89 (H) mm
Weight	N.W.: 2.35 kg G.W.: 3.0kg
Remote control distance	8.0m



Specifications and design are subject to change without prior notice.

## Troubleshooting tips

### **Troubleshooting tips** [Common]

Before calling for service, you can check the following items on symptoms and solutions:

#### **No sound or distorted sound:**

Ensure that the equipment is connected properly.  
Ensure that the input settings for the TV and stereo system are correct.  
Adjust the master volume using the GUI screen for player information.

#### **No picture:**

Ensure that the equipment is connected properly.  
Ensure that the input setting for the TV is "video".

#### **No play:**

Condensation has formed: wait about 1 to 2 hours to allow the player to dry out.  
This player can't play discs other than DVDs, SVCDs, MP3s, VCDs and CDs.  
The disc may be dirty and require cleaning .  
Ensure that the disc is installed with the label side up.

#### **No remote control:**

Check the batteries are installed with the correct polarities (+&-).  
The batteries are depleted: replace them with new ones.  
Point the remote control unit at the remote control sensor and operate.  
Remove the obstacles between the remote control unit and the remote control sensor.  
Operate the remote control unit at a distance of not more than 8 meters from the remote control sensor.

#### **No key operation (by the unit and/or the remote control) is effective:**

Turn the unit off and then back to on. Alternatively, turn off the unit, disconnect the AC power cord and the reconnect it. (The player may not be operating properly due to lightning, static electricity or some other external factor.)

#### **No MIC sound:**

Ensure that the connection is proper.  
Adjust MIC volume knobs at high level.

### **Troubleshooting tips** [DVD]

#### **Play does not commence even when title is selected:**

Confirm the "Rating" settings.

#### **Audio soundtrack and/or subtitle language is not the one selected at the initial settings:**

If the audio soundtrack and/or subtitle language does not exist on the disc, the language selected at the initial setting will not be seen/heard.

#### **No subtitles:**

Subtitles appear only with discs which contain them.

#### **Alternative audio soundtrack (or subtitle) language fail to be selected:**

- An alternative language is not selected with discs which do not contain more than one language.
- In the case of some discs, the alternative language cannot be selected by operating the AUDIO or SUBTITLE button. Try selecting it from the DVD menu if one is available.

#### **Angle cannot be changed:**

This function is dependent on software availability. Even if a disc has a number of angles recorded, these angles may be recorded for specific scenes only.

### **Troubleshooting tips** [SVCD/VCD]

#### **No menu play:**

This function works only for SVCDs/VCDs with playback control.

## Definition of terms

### Definition of terms

#### Angle

Recorded onto some DVD discs are scenes which have been simultaneously shot from a number of different angles (the same scene is shot from the front, front the left side, from the right side, etc.). With such discs, the ANGLE button can be used to view the scene from different angles.

#### DVD

This refers to a high-density optical disc on which high-quality pictures and sound have been recorded by means of digital signals. Incorporating a new video compression technology (MPEG II) and high-density recording technology, DVD enables aesthetically pleasing full-motion video to be recorded over long periods of time (for instance, a whole movie can be recorded).

DVD has a structure consisting of two 0.6mm thin discs which are adhered to each other. Since the thinner the disc, the higher the density at which the information can be recorded, a DVD disc has a greater capacity than a single 1.2mm thick disc. Since the two thin discs are adhered to each other, there is the potential to achieve double-sided play sometime in the future for even longer duration play.

#### Chapter number

These numbers are recorded on DVD discs. A title is subdivided into many sections, each of which is numbered, and specific parts of video presentations can be searched quickly using these numbers.

#### Subtitles

These are the printed lines appearing at the bottom of the screen which translate or transcribe the dialogue. They are recorded on DVD discs.

### Definition of terms

#### PBC (or Playback control)

This is recorded on a SVCD/VCD (2.0). The scenes or information to be viewed (or listened to) can be selected interactively with the TV monitor by looking at the menu shown on the TV monitor.

#### Track number

These numbers are assigned to the tracks which are recorded on Video CDs. They enable specific tracks to be located quickly.

#### Time number

This indicates the play time which has elapsed from the start of a disc or a title. It can be used to find a specific scene quickly. (It may not work with some discs.)

### Region management information

The Region number for this DVD/SUPER VCD/VCD/CD player is 4.



P/N: 0700-D26500-04

# DVD

Please fill the blanks with the model number and serial number of this player for future reference

Model no.:

Serial No.:



PALSONIC CORPORATION PTY LTD  
1 JOYNTON AVENUE  
WATERLOO NSW 2017 AUSTRALIA  
TEL: (02) 9313 7111  
FAX: (02) 9313 7555  
[www.palsonic.com.au](http://www.palsonic.com.au)

**PALSONIC CUSTOMER SERVICE  
TELEPHONE  
AUSTRALIA: 1300 657 888**